

Technical  
Drawing

Desenho  
Técnico

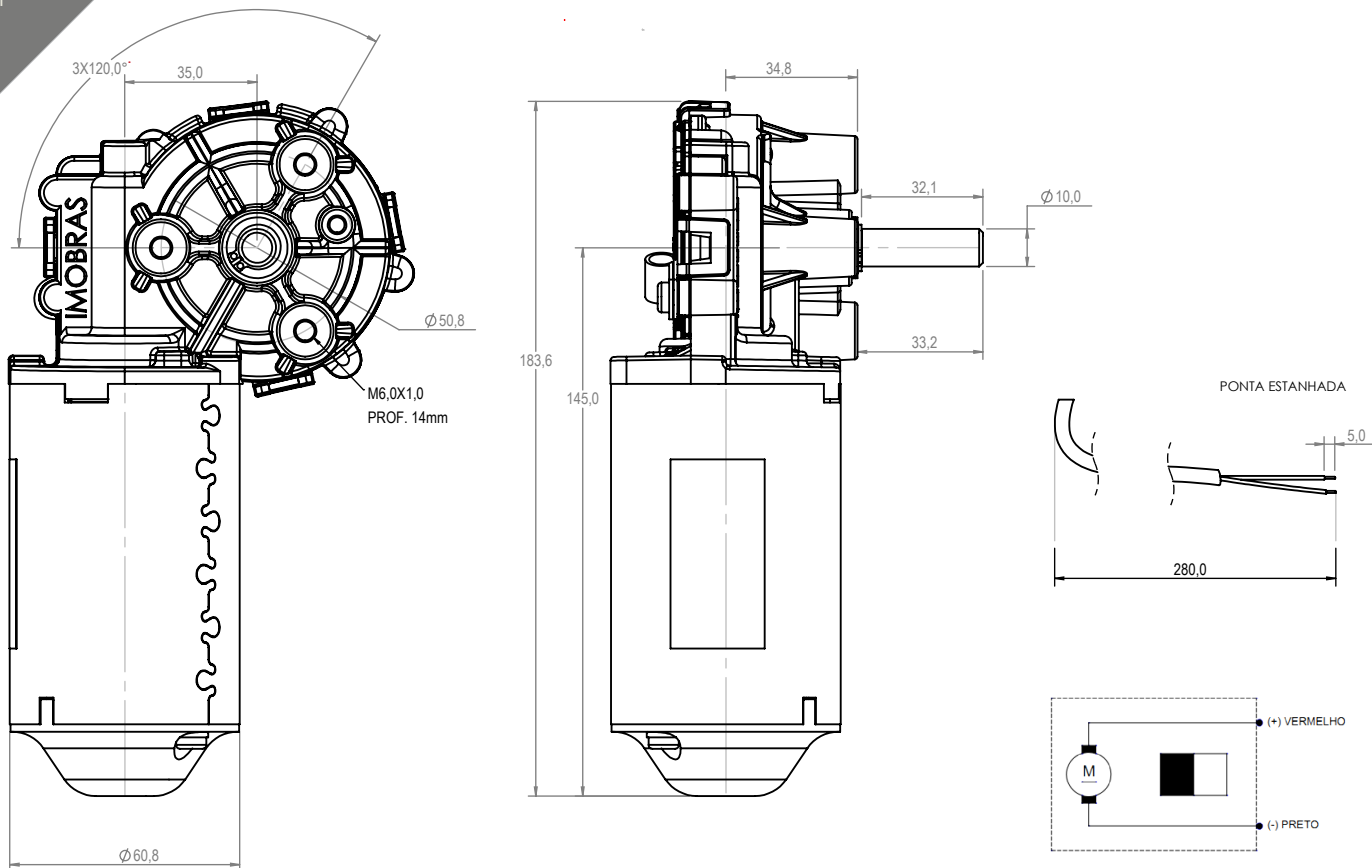

Technical  
Specification

Especificação  
Técnica

Imagem  
Ilustrativa

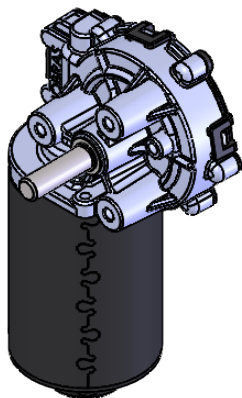

**100402812**

CARACTERÍSTICAS ELÉTRICAS	
U N (V)	13
P N (W)	30
n N (rpm)	45
I N (A)	5,5
I max (A)	44
M N (Nm)	6
M max (Nm)	30
i	63:1
Rotação	L / R
Peso (Kg)	1,500

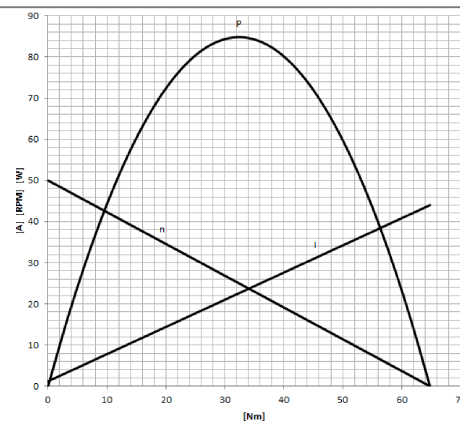

NOTAS:

Aplicação: Industrial

NOTES:

Application: industrial